

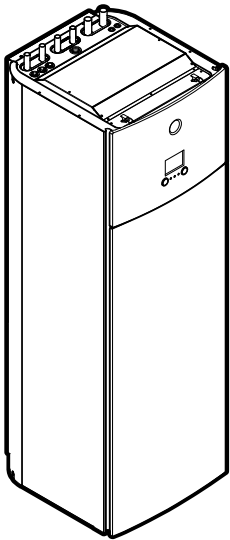

Operation manual



Daikin Altherma 3 GEO



EGSAH06D ▲ 9W ▼
EGSAH06UD ▲ 9W ▼
EGSAH10D ▲ 9W ▼
EGSAH10UD ▲ 9W ▼
EGSAX06D ▲ 9W ▼ (G)
EGSAX06UD ▲ 9W ▼
EGSAX10D ▲ 9W ▼ (G)
EGSAX10UD ▲ 9W ▼

▲ = 1, 2, 3, ..., 9, A, B, C, ..., Z
▼ = , , 1, 2, 3, ..., 9

Table of contents

1	About this document	2
2	User safety instructions	3
2.1	General.....	3
2.2	Instructions for safe operation.....	3
3	About the system	4
3.1	Components in a typical system layout.....	4
4	Quick guide	4
4.1	User permission level.....	4
4.2	Space heating/cooling.....	5
4.3	Domestic hot water.....	6
5	Operation	7
5.1	User interface: Overview.....	7
5.2	Menu structure: Overview user settings.....	8
5.3	Possible screens: Overview.....	9
5.3.1	Home screen.....	9
5.3.2	Main menu screen.....	10
5.3.3	Setpoint screen.....	10
5.3.4	Detailed screen with values.....	10
5.4	Turning operation ON or OFF.....	11
5.4.1	Visual indication.....	11
5.4.2	To turn ON or OFF.....	11
5.5	Reading out information.....	11
5.6	Space heating/cooling control.....	11
5.6.1	Setting the space operation mode.....	11
5.6.2	To change the desired room temperature.....	12
5.6.3	To change the desired leaving water temperature.....	12
5.7	Domestic hot water control.....	12
5.7.1	Reheat mode.....	12
5.7.2	Scheduled mode.....	13
5.7.3	Scheduled + reheat mode.....	13
5.7.4	Using DHW powerful operation.....	13
5.8	Schedule screen: Example.....	13
5.9	Weather-dependent curve.....	15
5.9.1	What is a weather-dependent curve?.....	15
5.9.2	2-points curve.....	15
5.9.3	Slope-offset curve.....	16
5.9.4	Using weather-dependent curves.....	16
6	Energy saving tips	17
7	Maintenance and service	18
7.1	Overview: Maintenance and service.....	18
8	Troubleshooting	18
8.1	To display the help text in case of a malfunction.....	18
8.2	To check the malfunction history.....	18
8.3	Symptom: You are feeling too cold (hot) in your living room.....	18
8.4	Symptom: The water at the tap is too cold.....	19
8.5	Symptom: Heat pump failure.....	19
8.6	Symptom: The system is making gurgling noises after commissioning.....	19
9	Disposal	19
10	Glossary	19
11	Installer settings: Tables to be filled in by installer	20
11.1	Configuration wizard.....	20
11.2	Settings menu.....	20

1 About this document

Thank you for purchasing this product. Please:

- Read the documentation carefully before operating the user interface to ensure the best possible performance.
- Request the installer to inform you about the settings that he used to configure your system. Check if he has filled in the installer settings tables. If NOT, request him to do so.
- Keep the documentation for future reference.

Target audience

End users

Documentation set

This document is part of a documentation set. The complete set consists of:

- **General safety precautions:**
 - Safety instructions that you must read before installing
 - Format: Paper (in the box of the unit)
- **Operation manual:**
 - Quick guide for basic usage
 - Format: Paper (in the box of the unit)
- **User reference guide:**
 - Detailed step-by-step instructions and background information for basic and advanced usage
 - Format: Digital files on <https://www.daikin.eu>. Use the search function 🔍 to find your model.
- **Installation manual:**
 - Installation instructions
 - Format: Paper (in the box of the unit)
- **Installer reference guide:**
 - Preparation of the installation, good practices, reference data, ...
 - Format: Digital files on <https://www.daikin.eu>. Use the search function 🔍 to find your model.
- **Addendum book for optional equipment:**
 - Additional info about how to install optional equipment
 - Format: Paper (in the box of the unit) + Digital files on <https://www.daikin.eu>. Use the search function 🔍 to find your model.

Latest revisions of the supplied documentation may be available on the regional Daikin website or via your installer.

The original documentation is written in English. All other languages are translations.

ONECTA app



If set up by your installer, you can use the ONECTA app to control and monitor the status of your system. For more information, see:

<http://www.onlinecontroller.daikineurope.com/>



Breadcrumbs

Breadcrumbs (example: [4.3]) help you to locate where you are in the menu structure of the user interface.

1	To enable the breadcrumbs: In the home screen or main menu screen, press the help button. The breadcrumbs appear in the top left corner of the screen.	?
2	To disable the breadcrumbs: Press the help button again.	?

This document also mentions these breadcrumbs. **Example:**

1	Go to [4.3] : Space heating/cooling > Operation range.	
---	---	--

This means:

1	Starting from the home screen, turn the left dial and go to Space heating/cooling.	
2	Press the left dial to enter the submenu.	
3	Turn the left dial and go to Operation range.	
4	Press the left dial to enter the submenu.	

2 User safety instructions

Always observe the following safety instructions and regulations.

2.1 General

WARNING

If you are NOT sure how to operate the unit, contact your installer.

WARNING

This appliance can be used by children aged from 8 years and above and persons with reduced physical, sensory or mental capabilities or lack of experience and knowledge if they have been given supervision or instruction concerning use of the appliance in a safe way and understand the hazards involved.

Children **SHALL NOT** play with the appliance.

Cleaning and user maintenance **SHALL NOT** be made by children without supervision.

WARNING

To prevent electrical shocks or fire:

- Do NOT rinse the unit.
- Do NOT operate the unit with wet hands.
- Do NOT place any objects containing water on the unit.

CAUTION

- Do NOT place any objects or equipment on top of the unit.
- Do NOT sit, climb or stand on the unit.

- Units are marked with the following symbol:



This means that electrical and electronic products may NOT be mixed with unsorted household waste. Do NOT try to dismantle the system yourself: dismantling the system, treatment of the refrigerant, of oil and of other parts **MUST** be done by an authorised installer and **MUST** comply with applicable legislation.

Units **MUST** be treated at a specialised treatment facility for reuse, recycling and recovery. By ensuring this product is disposed of correctly, you will help to prevent potential negative consequences for the environment and human health. For more information, contact your installer or local authority.

- Batteries are marked with the following symbol:



This means that the batteries may NOT be mixed with unsorted household waste. If a chemical symbol is printed beneath the symbol, this chemical symbol means that the battery contains a heavy metal above a certain concentration.

Possible chemical symbols are: Pb: lead (>0.004%).

Waste batteries **MUST** be treated at a specialised treatment facility for reuse. By ensuring waste batteries are disposed of correctly, you will help to prevent potential negative consequences for the environment and human health.

2.2 Instructions for safe operation

WARNING: MILDLY FLAMMABLE MATERIAL

The refrigerant inside this unit is mildly flammable.

WARNING

The appliance shall be stored so as to prevent mechanical damage and in a well-ventilated room without continuously operating ignition sources

3 About the system

(example: open flames, an operating gas appliance or an operating electric heater).



WARNING

- Do NOT pierce or burn refrigerant cycle parts.
- Do NOT use cleaning materials or means to accelerate the defrosting process other than those recommended by the manufacturer.
- Be aware that the refrigerant inside the system is odourless.

WARNING

- The refrigerant inside the unit is mildly flammable, but normally does NOT leak. If the refrigerant leaks in the room and comes in contact with fire from a burner, a heater, or a cooker, this may result in fire, or the formation of a harmful gas.
- Turn OFF any combustible heating devices, ventilate the room, and contact the dealer where you purchased the unit.
- Do NOT use the unit until a service person confirms that the part from which the refrigerant leaked has been repaired.

WARNING

Air purging heat emitters or collectors. Before you purge air from heat emitters or collectors, check if  or  is displayed on the home screen of the user interface.

- If not, you can purge air immediately.
- If yes, make sure that the room where you want to purge air is sufficiently ventilated. **Reason:** Refrigerant might leak into the water circuit, and subsequently into the room when you purge air from the heat emitters or collectors.

3 About the system

Depending on the system layout, the system can:

- Heat up a space
- Cool down a space
- Produce domestic hot water

INFORMATION

Cooling is only applicable in case of reversible models.

INFORMATION

If underfloor heating is installed in the main zone, then in cooling mode the main zone can only provide refreshment. Real cooling is then NOT allowed.

3.1 Components in a typical system layout

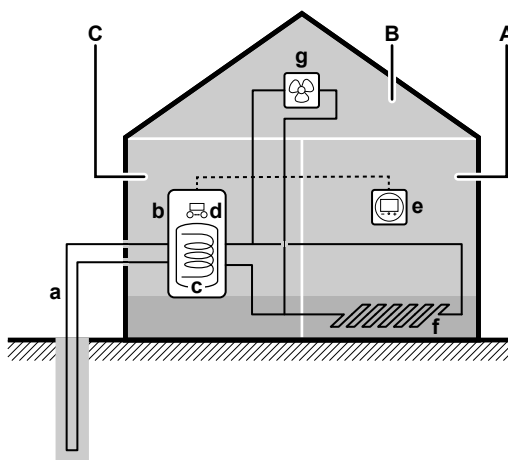

- A** Main zone. **Example:** Living room.
- B** Additional zone. **Example:** Bedroom.
- C** Technical room. **Example:** Garage.
- a** Brine loop
- b** Indoor unit heat pump
- c** Domestic hot water (DHW) tank
- d** User interface of the indoor unit
- e** Dedicated Human Comfort Interface (BRC1HHDA used as room thermostat)
- f** Underfloor heating
- g** Radiators, heat pump convectors, or fan coil units



4 Quick guide

4.1 User permission level

The amount of information you can read and edit in the menu structure depends on your user permission level:

- User: Standard mode
- Advanced user: You can read and edit more information

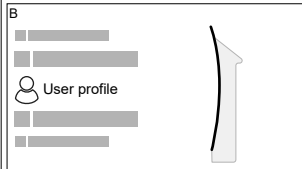
To change the user permission level

<p>1 Go to [B]: User profile.</p> 	
<p>2 Enter the applicable pin code for the user permission level.</p> <ul style="list-style-type: none"> ▪ Browse through the list of digits and change the selected digit. ▪ Move the cursor from left to right. ▪ Confirm the pin code and proceed. 	<p>—</p> <p>○...○</p> <p>○...○</p> <p>○...○</p>

User pin code

The User pin code is **0000**.

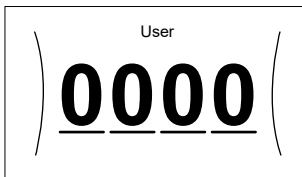

Advanced user pin code

The Advanced user pin code is **1234**. Additional menu items for the user are now visible.

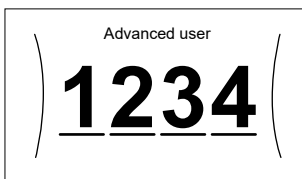



4.2 Space heating/cooling

To turn space heating/cooling operation ON or OFF



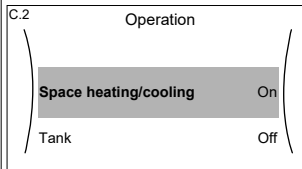

NOTICE

Room frost protection. Even if you turn OFF space heating/cooling operation ([C.2]: Operation > Space heating/cooling), room frost protection operation –if enabled– can still activate. However, for leaving water temperature control and external room thermostat control, the protection is NOT guaranteed.

<p>1 Go to [C.2]: Operation > Space heating/cooling.</p> 	
<p>2 Set operation to On or Off.</p>	<p>○...○</p>

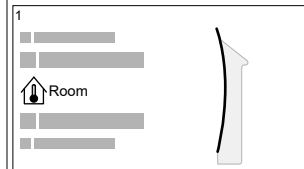

To change the desired room temperature

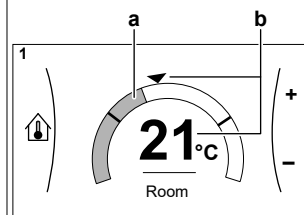
During room temperature control, you can use the room temperature setpoint screen to read out and adjust the desired room temperature.

<p>1 Go to [1]: Room.</p> 	
<p>2 Adjust the desired room temperature.</p>  <p>a Actual room temperature b Desired room temperature</p>	<p>○...○</p>

To change the desired leaving water temperature

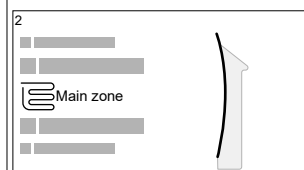
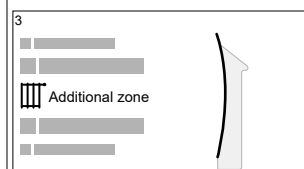
You can use the leaving water temperature setpoint screen to read out and adjust the desired leaving water temperature.

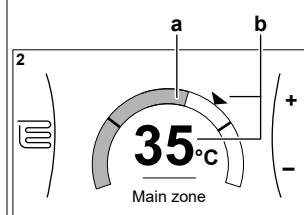
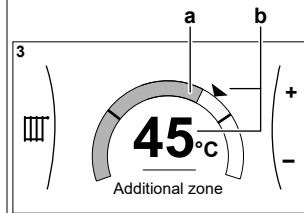
<p>1 Go to [2]: Main zone or [3]: Additional zone.</p>  	
<p>2 Adjust the desired leaving water temperature.</p>   <p>a Actual leaving water temperature b Desired leaving water temperature</p>	<p>○...○</p>

4 Quick guide

To change the weather-dependent curve for the space heating/cooling zones

1 Go to the applicable zone:

Zone	Go to ...
Main zone – Heating	[2.5] Main zone > Heating WD curve
Main zone – Cooling	[2.6] Main zone > Cooling WD curve
Additional zone – Heating	[3.5] Additional zone > Heating WD curve
Additional zone – Cooling	[3.6] Additional zone > Cooling WD curve

2 Change the weather-dependent curve.

There are 2 types of WD curves: **slope-offset curve** (default), and **2-points curve**. If needed, you can change the type in [2.E] Main zone > WD curve type. The way to adjust the curve depends on the type.

Slope-offset curve

Slope. When slope is changed, the new preferred temperature at X1 is unequally higher than the preferred temperature at X2.

Offset. When offset is changed, the new preferred temperature at X1 is equally higher as the preferred temperature at X2.

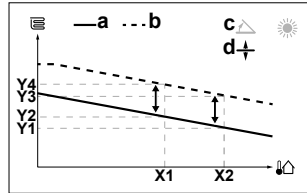
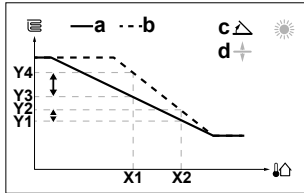

- X1, X2 Outdoor ambient temperature
- Y1~Y4 Desired leaving water temperature
- a WD curve before changes
- b WD curve after changes
- c Slope
- d Offset

Possible actions on this screen	
	Select slope or offset.
	Increase or decrease the slope/offset.
	When slope is selected: set slope and go to offset.
	When offset is selected: set offset.
	Confirm changes and return to the submenu.

2-points curve

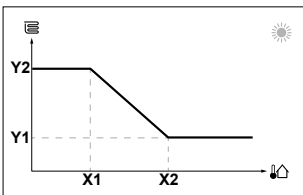

- X1, X2 Outdoor ambient temperature
- Y1, Y2 Desired leaving water temperature

Possible actions on this screen	
	Go through the temperatures.
	Change the temperature.
	Go to the next temperature.
	Confirm changes and proceed.

More information

For more information, see also:

- "5.4 Turning operation ON or OFF" ▶ 11]
- "5.6 Space heating/cooling control" ▶ 11]

- "5.8 Schedule screen: Example" ▶ 13]
- "5.9 Weather-dependent curve" ▶ 15]
- User reference guide

4.3 Domestic hot water

To turn tank heating operation ON or OFF



NOTICE

Disinfection mode. Even if you turn OFF tank heating operation ([C.3]: Operation > Tank), disinfection mode will remain active. However, if you turn it OFF while disinfection is running, an AH error occurs.

1	Go to [C.3]: Operation > Tank.	
2	Set operation to On or Off.	

To change the tank temperature setpoint

In Reheat only mode, you can use the tank temperature setpoint screen to read out and adjust the domestic hot water temperature.

1	Go to [5]: Tank.	
2	Adjust the domestic hot water temperature.	
	<p>a Actual domestic hot water temperature b Desired domestic hot water temperature</p>	

In other modes, you can only view the setpoint screen but not modify it. Instead, you can modify the settings for the Comfort setpoint [5.2], Eco setpoint [5.3] and Reheat setpoint [5.4].

More information

For more information, see also:

- "5.4 Turning operation ON or OFF" ▶ 11]
- "5.7 Domestic hot water control" ▶ 12]
- "5.8 Schedule screen: Example" ▶ 13]
- User reference guide

5 Operation



INFORMATION

Cooling is only applicable in case of reversible models.

5.1 User interface: Overview

The user interface has the following components:

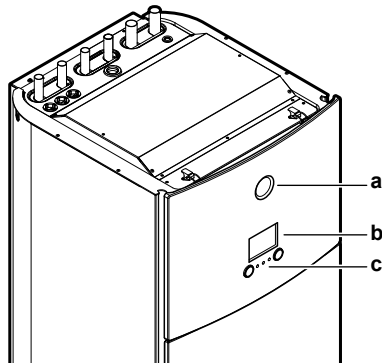

- a Status indicator
- b LCD screen
- c Dials and buttons

Status indicator

The LEDs of the status indicator light up or blink to show the operating mode of the unit.

LED	Mode	Description
Blinking blue	Standby	The unit is not in operation.
Continuous blue	Operation	The unit is in operation.
Blinking red	Malfunction	A malfunction occurred. See "8.1 To display the help text in case of a malfunction" [▶ 18] for more information.

LCD screen

The LCD screen has a sleeping function. After 15 min of non-interaction with the user interface, the screen darkens. Pressing any button or rotating any dial awakens the display.

Dials and buttons

You use the dials and buttons:

- To navigate through the screens, menus and settings of the LCD screen
- To set values

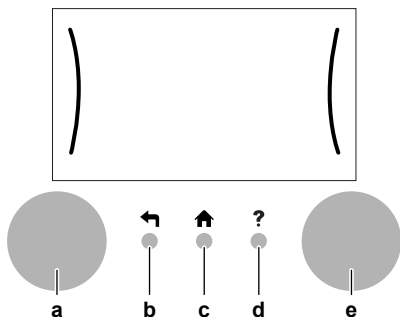

Item	Description
a Left dial	The LCD shows an arc on the left side of the display when you can use the left dial. <ul style="list-style-type: none"> ▪ : Turn, then press the left dial. Navigate through the menu structure. ▪ : Turn the left dial. Choose a menu item. ▪ : Press the left dial. Confirm your choice or go to a submenu.
b Back button	: Press to go back 1 step in the menu structure.
c Home button	: Press to go back to the home screen.
d Help button	: Press to show a help text related to the current page (if available).
e Right dial	The LCD shows an arc on the right side of the display when you can use the right dial. <ul style="list-style-type: none"> ▪ : Turn, then press the right dial. Change a value or setting, shown at the right side of the screen. ▪ : Turn the right dial. Navigate through the possible values and settings. ▪ : Press the right dial. Confirm your choice and go to the next menu item.

5 Operation

5.2 Menu structure: Overview user settings

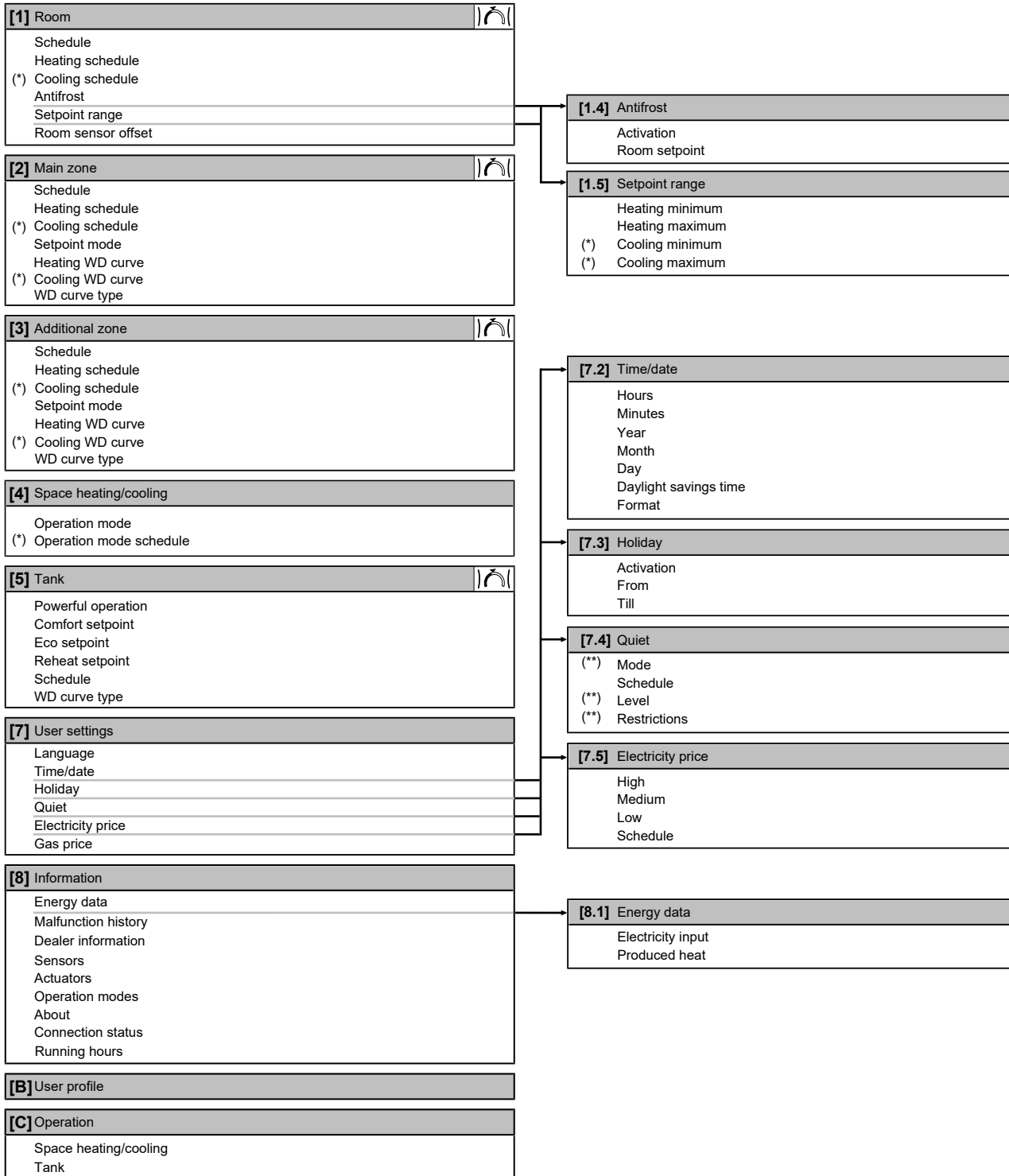

Setpoint screen

(*) Only applicable for models where cooling is possible

(**) Only accessible by installer



INFORMATION

Depending on the selected installer settings and unit type, settings will be visible/invisible.

5.3 Possible screens: Overview

The most common screens are as follows:

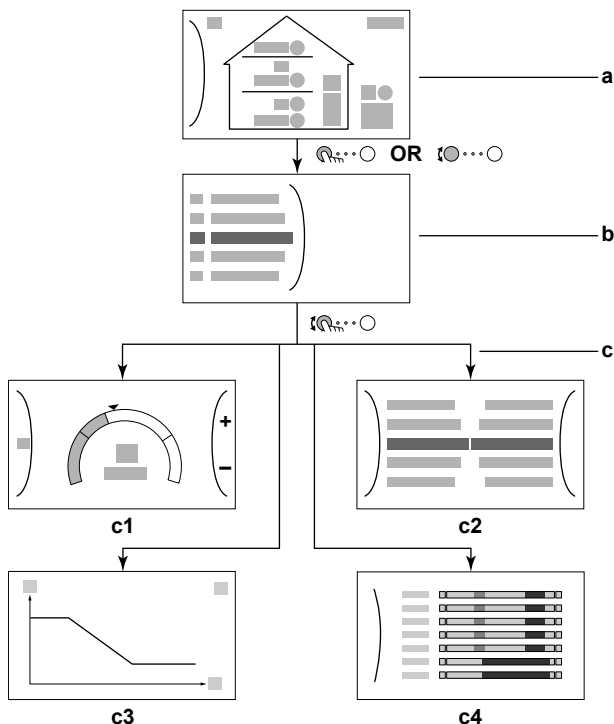

- a Home screen
- b Main menu screen
- c Lower level screens:
 - c1: Setpoint screen
 - c2: Detailed screen with values
 - c3: Screen with weather-dependent curve
 - c4: Screen with schedule

5.3.1 Home screen

Press the button to go back to the home screen. You see an overview of the unit configuration and the room and setpoint temperatures. Only symbols applicable for your configuration are visible on the home screen.

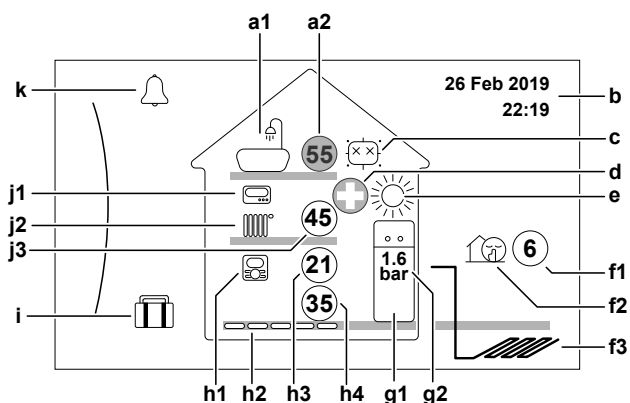

Possible actions on this screen	
	Go through the list of the main menu.
	Go to the main menu screen.
	Enable/disable breadcrumbs.

Item	Description
a	Domestic hot water
a1	Domestic hot water
a2	Measured tank temperature ⁽¹⁾

Item	Description
b	Current date and time
c	Disinfection mode active
	Powerful operation mode active
d	Emergency
	Heat pump failure and system operates in Emergency mode or heat pump is forced off.
e	Space operation mode
	Cooling
	Heating
f	Outdoor / quiet mode
f1	Measured outdoor temperature ⁽¹⁾
f2	Quiet mode active
f3	Outdoor brine piping
g	Indoor unit / domestic hot water tank
g1	Floor-standing indoor unit with integrated tank
g2	Water pressure
h	Main zone
h1	Installed room thermostat type:
	Unit operation is decided based on the ambient temperature of the dedicated Human Comfort Interface (BRC1HHDA used as room thermostat).
	Unit operation is decided by the external room thermostat (wired or wireless).
—	No room thermostat installed or set. Unit operation is decided based on the leaving water temperature regardless of the actual room temperature and/or heating demand of the room.
h2	Installed heat emitter type:
	Underfloor heating
	Fancoil unit
	Radiator
h3	Measured room temperature ⁽¹⁾
h4	Leaving water temperature setpoint ⁽¹⁾
i	Holiday mode
	Holiday mode active
j	Additional zone
j1	Installed room thermostat type:
	Unit operation is decided by the external room thermostat (wired or wireless).
	—
j2	Installed heat emitter type:
	Underfloor heating
	Fancoil unit
	Radiator
j3	Leaving water temperature setpoint ⁽¹⁾

5 Operation

Item	Description
k Malfunction	
	A malfunction occurred.
	See "8.1 To display the help text in case of a malfunction" [▶ 18] for more information.

- (1) If the corresponding operation (for example: space heating) is not active, the circle is greyed out.

5.3.2 Main menu screen

Starting from the home screen, press () or turn () the left dial to open the main menu screen. From the main menu, you can access the different setpoint screens and submenus.

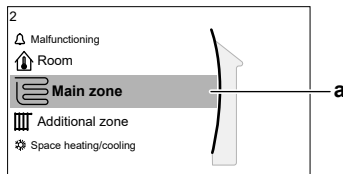

a Selected submenu

Possible actions on this screen	
	Go through the list.
	Enter the submenu.
?	Enable/disable breadcrumbs.

Submenu	Description
[0] or Malfunctioning	Restriction: Only displayed if a malfunction occurs. See "8.1 To display the help text in case of a malfunction" [▶ 18] for more information.
[1] Room	Restriction: Only displayed if a dedicated Human Comfort Interface (BRC1HHDA used as room thermostat) is controlling the indoor unit. Set the room temperature.
[2] Main zone	Shows the applicable symbol for your main zone emitter type. Set the leaving water temperature for the main zone.
[3] Additional zone	Restriction: Only displayed if there are two leaving water temperature zones. Shows the applicable symbol for your additional zone emitter type. Set the leaving water temperature for the additional zone (if present).
[4] Space heating/cooling	Shows the applicable symbol of your unit. Put the unit in heating mode or cooling mode. You cannot change the mode on heating only models.
[5] Tank	Set the domestic hot water tank temperature.
[7] User settings	Gives access to user settings such as holiday mode and quiet mode.
[8] Information	Displays data and information about the indoor unit.
[9] Installer settings	Restriction: Only for the installer. Gives access to advanced settings.
[A] Commissioning	Restriction: Only for the installer. Perform tests and maintenance.

Submenu	Description
[B] User profile	Change the active user profile.
[C] Operation	Turn heating/cooling functionality and domestic hot water preparation on or off.

5.3.3 Setpoint screen

The setpoint screen is displayed for screens describing system components that need a setpoint value.

Examples

[1] Room temperature screen

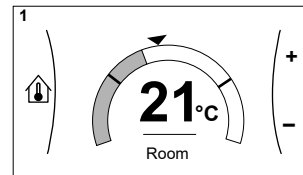

[2] Main zone screen

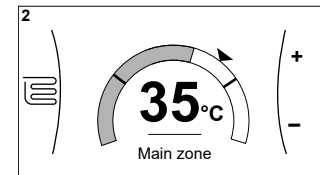

[3] Additional zone screen

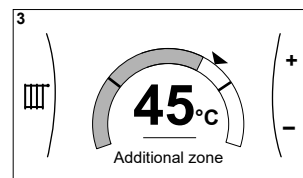

[5] Tank temperature screen

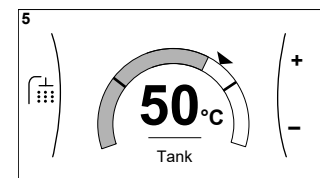

Explanation

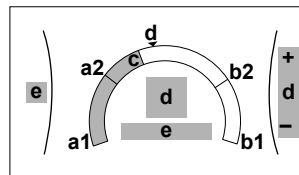

Possible actions on this screen	
	Go through the list of the submenu.
	Go to the submenu.
	Adjust and automatically apply the desired temperature.

Item	Description
Minimum temperature limit	a1 Fixed by the unit
	a2 Restricted by the installer
Maximum temperature limit	b1 Fixed by the unit
	b2 Restricted by the installer
Current temperature	c Measured by the unit
Desired temperature	d Turn the right dial to increase/decrease.
Submenu	e Turn or press the left dial to go to the submenu.

5.3.4 Detailed screen with values

Example:

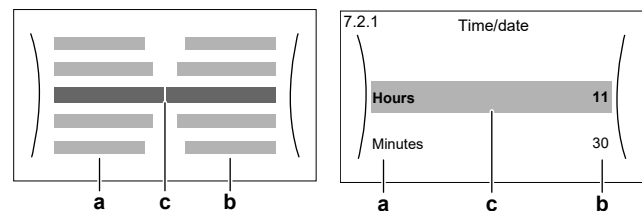

a Settings

- b Values
- c Selected setting and value

Possible actions on this screen	
	Go through the list of settings.
	Change the value.
	Go to the next setting.
	Confirm changes and proceed.

5.4 Turning operation ON or OFF

5.4.1 Visual indication

Certain functionalities of the unit can be enabled or disabled separately. If a functionality is disabled, the corresponding temperature icon in the home screen will be greyed out.

Space heating/cooling operation

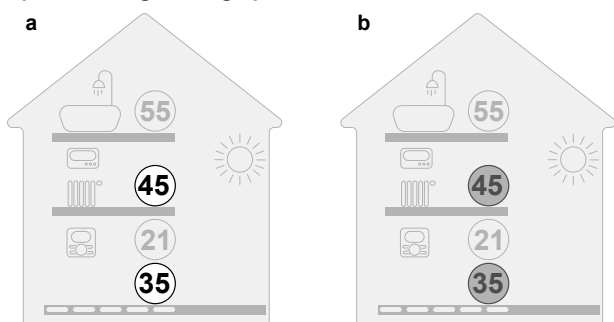

- a Space heating/cooling operation ON
- b Space heating/cooling operation OFF

Tank heating operation

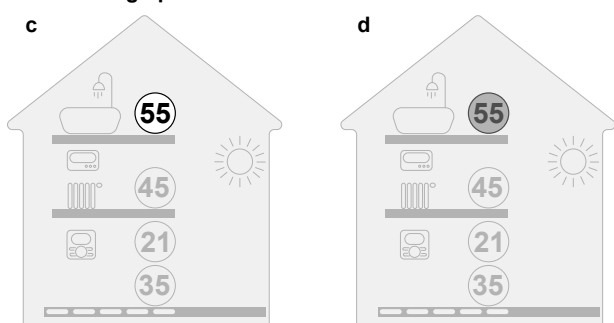

- c Tank heating operation ON
- d Tank heating operation OFF

5.4.2 To turn ON or OFF

Space heating/cooling operation



NOTICE

Room frost protection. Even if you turn OFF space heating/cooling operation ([C.2]: Operation > Space heating/cooling), room frost protection operation –if enabled– can still activate. However, for leaving water temperature control and external room thermostat control, the protection is NOT guaranteed.

1	Go to [C.2]: Operation > Space heating/cooling.	
2	Set operation to On or Off.	

Tank heating operation



NOTICE

Disinfection mode. Even if you turn OFF tank heating operation ([C.3]: Operation > Tank), disinfection mode will remain active. However, if you turn it OFF while disinfection is running, an AH error occurs.

1	Go to [C.3]: Operation > Tank.	
2	Set operation to On or Off.	

5.5 Reading out information

To read out information

1	Go to [8]: Information.	
---	-------------------------	--

Possible read-out information

In menu...	You can read out...
[8.1] Energy data	Produced energy, consumed electricity, and consumed gas
[8.2] Malfunction history	Malfunction history
[8.3] Dealer information	Contact/helpdesk number
[8.4] Sensors	Room, tank or domestic hot water, outside, and leaving water temperature (if applicable)
[8.5] Actuators	Status/mode of each actuator Example: Domestic hot water pump ON/OFF
[8.6] Operation modes	Current operation mode Example: Defrost/oil return mode
[8.7] About	Version information about the system Contains a link (QR code) to the online documentation
[8.8] Connection status	Information about the connection status of the unit, the room thermostat and the LAN adapter

5.6 Space heating/cooling control

5.6.1 Setting the space operation mode

About space operation modes

Your unit can be a heating or a heating/cooling model:

- If your unit is a heating model, it can heat up a space.
- If your unit is a heating/cooling model, it can both heat up and cool down a space. You have to tell the system which operation mode to use.

To tell the system which space operation to use, you can:

You can...	Location
Check which space operation mode is currently used.	Home screen
Set the space operation mode permanently.	Main menu
Restrict automatic changeover according to a monthly schedule.	

5 Operation

To set the space operation mode

1	Go to [4.1]: Space heating/cooling > Operation mode	
2	Select one of the following options: <ul style="list-style-type: none"> Heating: Only heating mode Cooling: Only cooling mode Automatic: The operation mode changes automatically between heating and cooling based on the outdoor temperature. Restricted per month according to the Operation mode schedule [4.2]. 	

To restrict automatic changeover according to a schedule

Conditions: You set the space operation mode to Automatic.

1	Go to [4.2]: Space heating/cooling > Operation mode schedule.	
2	Select a month.	
3	For each month, select an option: <ul style="list-style-type: none"> Reversible: Not restricted Heating only: Restricted Cooling only: Restricted 	
4	Confirm the changes.	

5.6.2 To change the desired room temperature

During room temperature control, you can use the room temperature setpoint screen to read out and adjust the desired room temperature.

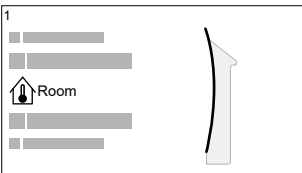
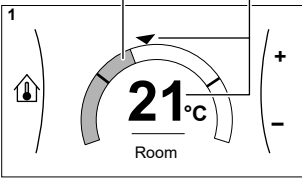
1	Go to [1]: Room. 	
2	Adjust the desired room temperature.  <p>a Actual room temperature b Desired room temperature</p>	

If scheduling is on after changing the desired room temperature

- The temperature will stay the same as long as there is no scheduled action.
- The desired room temperature will return to its scheduled value whenever a scheduled action occurs.

You can avoid scheduled behaviour by (temporarily) turning off scheduling.

To turn off room temperature scheduling

1	Go to [1.1]: Room > Schedule.	
2	Select No.	

5.6.3 To change the desired leaving water temperature



INFORMATION

The leaving water is the water that is sent to the heat emitters. The desired leaving water temperature is set by your installer in accordance with the heat emitter type. Only adjust the leaving water temperature settings in case of problems.

You can use the leaving water temperature setpoint screen to read out and adjust the desired leaving water temperature.

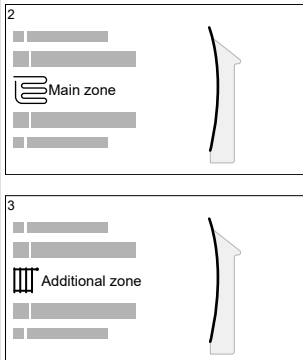
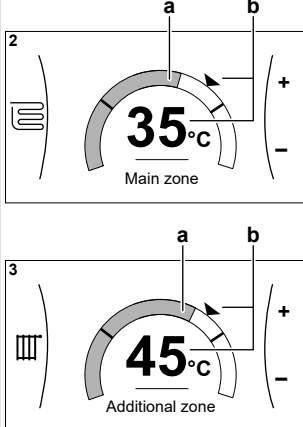
1	Go to [2]: Main zone or [3]: Additional zone. 	
2	Adjust the desired leaving water temperature.  <p>a Actual leaving water temperature b Desired leaving water temperature</p>	

5.7 Domestic hot water control

5.7.1 Reheat mode

In reheat mode, the DHW tank continuously heats up to the temperature shown on the home screen (example: 50°C) when the temperature drops below a certain value.

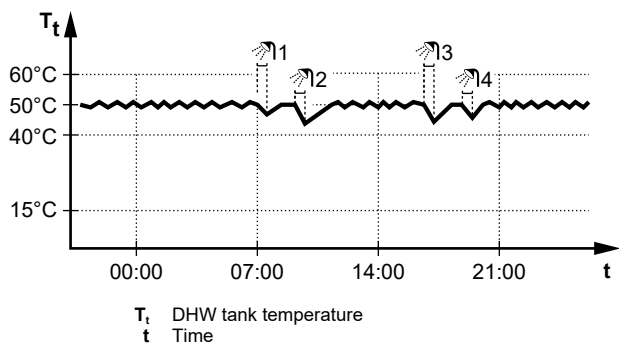

i INFORMATION

When the DHW tank mode is reheat, the risk for capacity shortage and comfort problem is significant. In case of frequent reheat operation, space heating/cooling function is regularly interrupted.

5.7.2 Scheduled mode

In scheduled mode, the DHW tank produces hot water corresponding to a schedule. The best time to allow the tank to produce hot water is at night, because the space heating demand is lower.

Example:

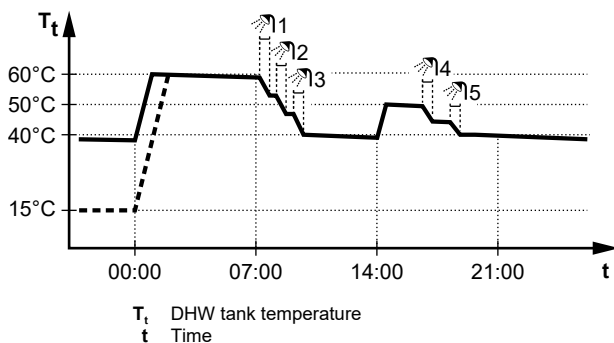

- Initially, the DHW tank temperature is the same as the temperature of the domestic water entering the DHW tank (example: 15°C).
- At 00:00 the DHW tank is programmed to heat up the water to a preset value (example: Comfort = 60°C).
- During the morning, you consume hot water and the DHW tank temperature decreases.
- At 14:00 the DHW tank is programmed to heat up the water to a preset value (example: Eco = 50°C). Hot water is available again.
- During the afternoon and evening, you consume hot water again and the DHW tank temperature decreases again.
- At 00:00 the next day, the cycle repeats.

5.7.3 Scheduled + reheat mode

In scheduled + reheat mode, the domestic hot water control is the same as in scheduled mode. However, when the DHW tank temperature drops below a preset value (=reheat tank temperature – hysteresis value; example: 35°C), the DHW tank heats up until it reaches the reheat set point (example: 45°C). This ensures that a minimum amount of hot water is available at all times.

Example:

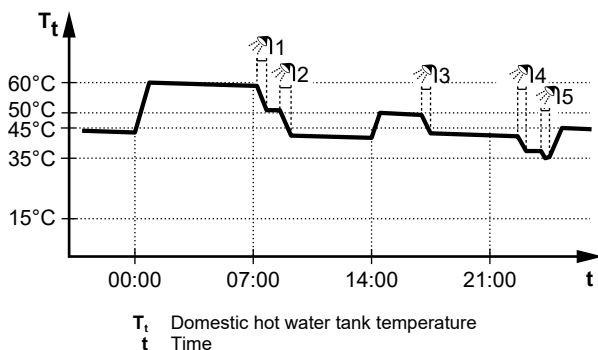

5.7.4 Using DHW powerful operation



About powerful operation

Powerful operation allows the domestic hot water to be heated by the backup heater. Use this mode on days when there is more hot water usage than usual.

To check if powerful operation is active

If  is displayed on the home screen, powerful operation is active.

Activate or deactivate Powerful operation as follows:

1	Go to [5.1]: Tank > Powerful operation	
2	Turn powerful operation Off or On.	

Usage example: You immediately need more hot water

You are in the following situation:

- You already consumed most of your domestic hot water.
- You cannot wait for the next scheduled action to heat up the domestic hot water tank.

Then you can activate powerful operation. The domestic hot water tank will start heating up the water to the Comfort temperature.

i INFORMATION

When powerful operation is active, the risk of space heating/cooling and capacity shortage comfort problems is significant. In case of frequent domestic hot water operation, frequent and long space heating/cooling interruptions will happen.

5.8 Schedule screen: Example

This example shows how to set a room temperature schedule in heating mode for the main zone.

i INFORMATION

The procedures to program other schedules are similar.

To program the schedule: overview

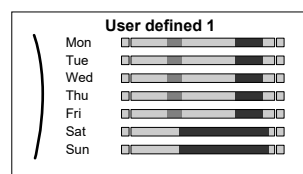

Example: You want to program the following schedule:



Prerequisite: The room temperature schedule is only available if room thermostat control is active. If leaving water temperature control is active, you can program the main zone schedule instead.





- Go to the schedule.
- (optional) Clear the content of the whole week schedule or the content of a selected day schedule.
- Program the schedule for Monday.
- Copy the schedule to the other weekdays.
- Program the schedule for Saturday and copy it to Sunday.
- Give the schedule a name.

To go to the schedule



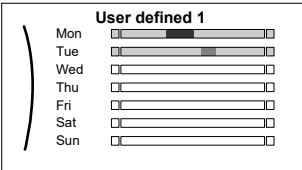

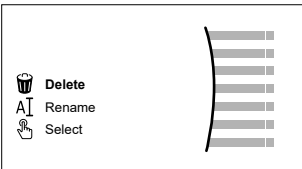
1	Go to [1.1]: Room > Schedule.	
2	Set scheduling to Yes.	
3	Go to [1.2]: Room > Heating schedule.	

5 Operation



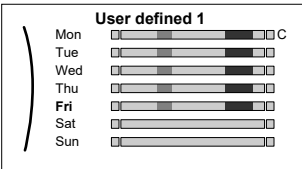

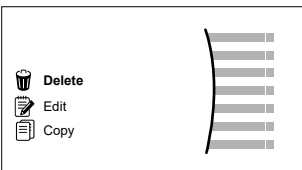
To clear the content of the week schedule

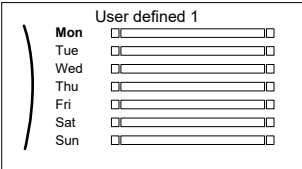

<p>1 Select the name of the current schedule.</p> 	
<p>2 Select Delete.</p> 	
<p>3 Select OK to confirm.</p>	

To clear the content of a day schedule

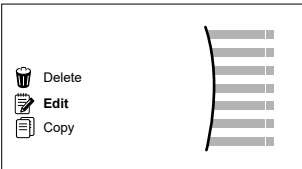



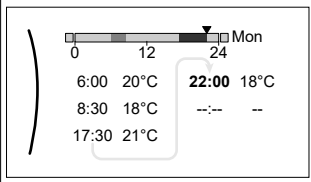

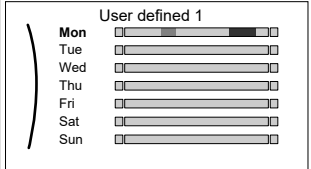

<p>1 Select the day of which you want to clear the content. For example Friday</p> 	
<p>2 Select Delete.</p> 	
<p>3 Select OK to confirm.</p>	

To program the schedule for Monday

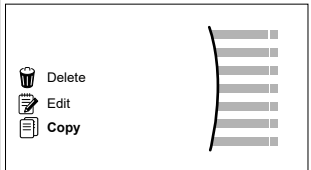
<p>1 Select Monday.</p> 	
<p>2 Select Edit.</p> 	

<p>3 Use the left dial to select an entry and edit the entry with the right dial. You can program up to 6 actions each day. On the bar, a high temperature has a darker colour than a low temperature.</p>  <p>Note: To clear an action, set its time as the time of the previous action.</p>	
<p>4 Confirm the changes.</p> <p>Result: The schedule for Monday is defined. The value of the last action is valid until the next programmed action. In this example, Monday is the first day you programmed. Thus, the last programmed action is valid up to the first action of next Monday.</p>	

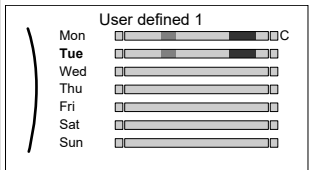
To copy the schedule to the other weekdays

<p>1 Select Monday.</p> 	
<p>2 Select Copy.</p>  <p>Result: Next to the copied day, "C" is displayed.</p>	
<p>3 Select Tuesday.</p> 	
<p>4 Select Paste.</p>  <p>Result:</p> 	

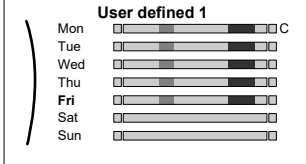
5	Repeat this action for all other weekdays.	—
		

To program the schedule for Saturday and copy it to Sunday

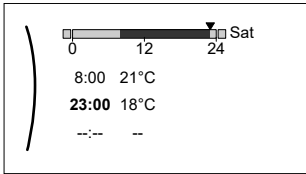
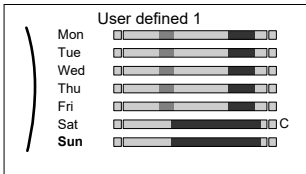
1	Select Saturday.	
2	Select Edit.	
3	Use the left dial to select an entry and edit the entry with the right dial.	
		
4	Confirm the changes.	
5	Select Saturday.	
6	Select Copy.	
7	Select Sunday.	
8	Select Paste.	
<p>Result:</p> 		

To rename the schedule

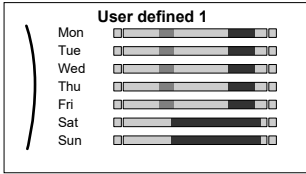
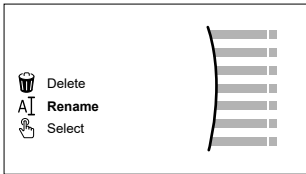
1	Select the name of the current schedule.	
		
2	Select Rename.	
		
3	(optional) To delete the current schedule name, browse through the character list until ← is displayed, then press to remove the previous character. Repeat for each character of the schedule name.	
4	To name the current schedule, browse through the character list and confirm the selected character. The schedule name can contain up to 15 characters.	
5	Confirm the new name.	

i **INFORMATION**
Not all schedules can be renamed.

5.9 Weather-dependent curve

5.9.1 What is a weather-dependent curve?

Weather-dependent operation

The unit operates 'weather-dependent' if the desired leaving water or tank temperature is determined automatically by the outdoor temperature. It therefore is connected to a temperature sensor on the North wall of the building. If the outdoor temperature drops or rises, the unit compensates instantly. Thus, the unit does not have to wait for feedback by the thermostat to increase or decrease the temperature of the leaving water or tank. Because it reacts more quickly, it prevents high rises and drops of the indoor temperature and water temperature at tap points.

Advantage

Weather-dependent operation reduces energy consumption.

Weather-dependent curve

To be able to compensate for differences in temperature, the unit relies on its weather-dependent curve. This curve defines how much the temperature of the tank or leaving water must be at different outdoor temperatures. Because the slope of the curve depends on local circumstances such as climate and the insulation of the building, the curve can be adjusted by an installer or user.

Types of weather-dependent curve

There are 2 types of weather-dependent curves:

- 2-points curve
- Slope-offset curve

Which type of curve you use to make adjustments, depends on your personal preference. See "5.9.4 Using weather-dependent curves" [▶ 16].

Availability

The weather-dependent curve is available for:

- Main zone - Heating
- Main zone - Cooling
- Additional zone - Heating
- Additional zone - Cooling
- Tank (only available to installers)

i **INFORMATION**

To operate weather-dependent, correctly configure the setpoint of the main zone, additional zone or tank. See "5.9.4 Using weather-dependent curves" [▶ 16].

5.9.2 2-points curve

Define the weather-dependent curve with these two setpoints:

- Setpoint (X1, Y2)
- Setpoint (X2, Y1)

Example

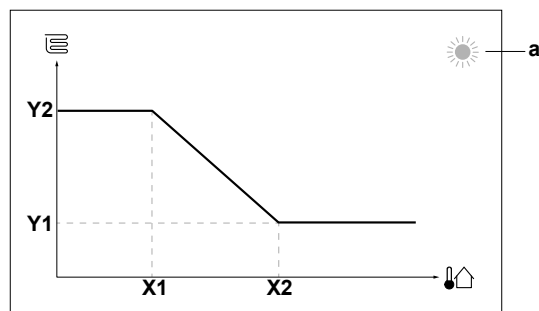

5 Operation

Item	Description
a	Selected weather-dependent zone: <ul style="list-style-type: none"> ☀: Main zone or additional zone heating ❄: Main zone or additional zone cooling 🏠: Domestic hot water
X1, X2	Examples of outdoor ambient temperature
Y1, Y2	Examples of desired tank temperature or leaving water temperature. The icon corresponds to the heat emitter for that zone: <ul style="list-style-type: none"> 🏠: Underfloor heating 📄: Fan coil unit 🔱: Radiator 🏠: Domestic hot water tank

Possible actions on this screen	
⏪⋯⋯⋯⏩	Go through the temperatures.
⏪⋯⋯⋯⏩	Change the temperature.
⏪⋯⋯⏩	Go to the next temperature.
⏪⋯⋯⏩	Confirm changes and proceed.

5.9.3 Slope-offset curve

Slope and offset

Define the weather-dependent curve by its slope and offset:

- Change the **slope** to differently increase or decrease the temperature of the leaving water for different ambient temperatures. For example, if leaving water temperature is in general fine but at low ambient temperatures too cold, raise the slope so that leaving water temperature is heated increasingly more at decreasingly lower ambient temperatures.
- Change the **offset** to equally increase or decrease the temperature of the leaving water for different ambient temperatures. For example, if leaving water temperature is always a bit too cold at different ambient temperatures, shift the offset up to equally increase the leaving water temperature for all ambient temperatures.

Examples

Weather-dependent curve when slope is selected:

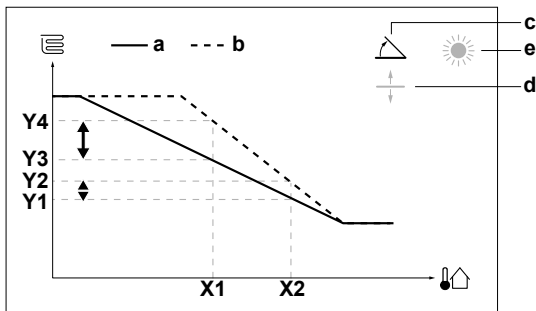

Weather-dependent curve when offset is selected:

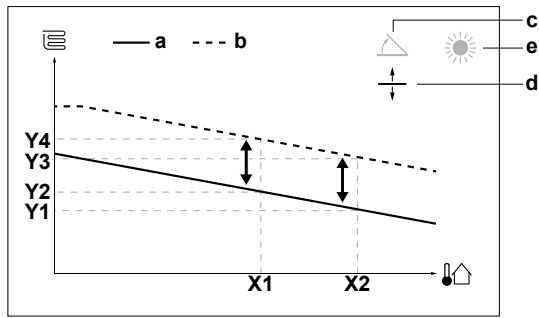

Item	Description
a	WD curve before changes.
b	WD curve after changes (as example): <ul style="list-style-type: none"> When slope is changed, the new preferred temperature at X1 is unequally higher than the preferred temperature at X2. When offset is changed, the new preferred temperature at X1 is equally higher as the preferred temperature at X2.
c	Slope
d	Offset
e	Selected weather-dependent zone: <ul style="list-style-type: none"> ☀: Main zone or additional zone heating ❄: Main zone or additional zone cooling 🏠: Domestic hot water
X1, X2	Examples of outdoor ambient temperature
Y1, Y2, Y3, Y4	Examples of desired tank temperature or leaving water temperature. The icon corresponds to the heat emitter for that zone: <ul style="list-style-type: none"> 🏠: Underfloor heating 📄: Fan coil unit 🔱: Radiator 🏠: Domestic hot water tank

Possible actions on this screen	
⏪⋯⋯⋯⏩	Select slope or offset.
⏪⋯⋯⋯⏩	Increase or decrease the slope/offset.
⏪⋯⋯⏩	When slope is selected: set slope and go to offset. When offset is selected: set offset.
⏪⋯⋯⏩	Confirm changes and return to the submenu.

5.9.4 Using weather-dependent curves

Configure weather-dependent curves as following:

To define the setpoint mode

To use the weather-dependent curve, you need to define the correct setpoint mode:

Go to setpoint mode ...	Set the setpoint mode to ...
Main zone – Heating	
[2.4] Main zone > Setpoint mode	WD heating, fixed cooling OR weather dependent
Main zone – Cooling	
[2.4] Main zone > Setpoint mode	Weather dependent

Go to setpoint mode ...	Set the setpoint mode to ...
Additional zone – Heating	
[3.4] Additional zone > Setpoint mode	WD heating, fixed cooling OR Weather dependent
Additional zone – Cooling	
[3.4] Additional zone > Setpoint mode	Weather dependent
Tank	
[5.B] Tank > Setpoint mode	Restriction: Only available to installers. Weather dependent

To change the type of weather-dependent curve

To change the type for all zones (main + additional) and for the tank, go to [2.E] Main zone > WD curve type.

Viewing which type is selected is also possible via:

- [3.C] Additional zone > WD curve type
- [5.E] Tank > WD curve type

Restriction: Only available to installers.

To change the weather-dependent curve

Zone	Go to ...
Main zone – Heating	[2.5] Main zone > Heating WD curve
Main zone – Cooling	[2.6] Main zone > Cooling WD curve
Additional zone – Heating	[3.5] Additional zone > Heating WD curve
Additional zone – Cooling	[3.6] Additional zone > Cooling WD curve
Tank	Restriction: Only available to installers. [5.C] Tank > WD curve



INFORMATION

Maximum and minimum setpoints

You cannot configure the curve with temperatures that are higher or lower than the set maximum and minimum setpoints for that zone or for the tank. When the maximum or minimum setpoint is reached, the curve flattens out.

To fine-tune the weather-dependent curve: slope-offset curve

The following table describes how to fine-tune the weather-dependent curve of a zone or tank:

You feel ...		Fine-tune with slope and offset:	
At regular outdoor temperatures ...	At cold outdoor temperatures ...	Slope	Offset
OK	Cold	↑	—
OK	Hot	↓	—
Cold	OK	↓	↑
Cold	Cold	—	↑
Cold	Hot	↓	↑
Hot	OK	↑	↓
Hot	Cold	↑	↓
Hot	Hot	—	↓

To fine-tune the weather-dependent curve: 2-points curve

The following table describes how to fine-tune the weather-dependent curve of a zone or tank:

You feel ...		Fine-tune with setpoints:			
At regular outdoor temperatures ...	At cold outdoor temperatures ...	Y2 ^(a)	Y1 ^(a)	X1 ^(a)	X2 ^(a)
OK	Cold	↑	—	↑	—
OK	Hot	↓	—	↓	—
Cold	OK	—	↑	—	↑
Cold	Cold	↑	↑	↑	↑
Cold	Hot	↓	↑	↓	↑
Hot	OK	—	↓	—	↓
Hot	Cold	↑	↓	↑	↓
Hot	Hot	↓	↓	↓	↓

^(a) See "5.9.2 2-points curve" [p. 15].

6 Energy saving tips

Tips about room temperature

- Make sure the desired room temperature is NEVER too high (in heating mode) or too low (in cooling mode), but ALWAYS according to your actual needs. Each saved degree can save up to 6% of heating/cooling costs.
- Do NOT increase/decrease the desired room temperature to speed up space heating/cooling. The space will NOT heat up/cool down faster.
- When your system layout contains slow heat emitters (example: underfloor heating), avoid large fluctuation of the desired room temperature and do NOT let the room temperature drop too low/rise too high. It will take more time and energy to heat up/cool down the room again.
- Use a weekly schedule for your normal space heating or cooling needs. If necessary, you can easily deviate from the schedule:
 - For shorter periods: You can overrule the scheduled room temperature until the next scheduled action. **Example:** When you have a party, or when you are leaving for a couple of hours.
 - For longer periods: You can use the holiday mode.

Tips about DHW tank temperature

- Use a weekly schedule for your normal domestic hot water needs (ONLY in scheduled mode).
 - Program to heat up the DHW tank to a preset value (Comfort = higher DHW tank temperature) during the night, because then space heating demand is lower.
 - If heating up the DHW tank once at night is NOT sufficient, program to additionally heat up the DHW tank to a preset value (Eco = lower DHW tank temperature) during the day.
- Make sure the desired DHW tank temperature is NOT too high. **Example:** After installation, lower the DHW tank temperature daily by 1°C and check if you still have enough hot water.
- Program to turn ON the domestic hot water pump ONLY during periods of the day when instant hot water is necessary. **Example:** In the morning and evening.

7 Maintenance and service

7 Maintenance and service

7.1 Overview: Maintenance and service

The installer has to perform a yearly maintenance. You can find the contact/helpdesk number via the user interface.

1	Go to [8.3]: Information > Dealer information.	
---	--	--

As end user, you have to:

- Keep the area around the unit clean.
- Keep the user interface clean with a soft damp cloth. Do NOT use any detergents.
- Regularly check if the water pressure is above 1 bar.

Refrigerant

This product contains fluorinated greenhouse gases. Do NOT vent gases into the atmosphere.

Refrigerant type: R32

Global warming potential (GWP) value: 675

Periodical inspections for refrigerant leaks may be required depending on the applicable legislation. Contact your installer for more information.

NOTICE

Applicable legislation on **fluorinated greenhouse gases** requires that the refrigerant charge of the unit is indicated both in weight and CO₂ equivalent.

Formula to calculate the quantity in CO₂ equivalent tonnes: GWP value of the refrigerant × total refrigerant charge [in kg]/1000

Contact your installer for more information.

WARNING: FLAMMABLE MATERIAL

The refrigerant inside this unit is mildly flammable.

WARNING

- The refrigerant inside the unit is mildly flammable, but normally does NOT leak. If the refrigerant leaks in the room and comes in contact with fire from a burner, a heater, or a cooker, this may result in fire, or the formation of a harmful gas.
- Turn OFF any combustible heating devices, ventilate the room, and contact the dealer where you purchased the unit.
- Do NOT use the unit until a service person confirms that the part from which the refrigerant leaked has been repaired.

WARNING

The appliance shall be stored in a room without continuously operating ignition sources (example: open flames, an operating gas appliance or an operating electric heater).

WARNING

- Do NOT pierce or burn refrigerant cycle parts.
- Do NOT use cleaning materials or means to accelerate the defrosting process other than those recommended by the manufacturer.
- Be aware that the refrigerant inside the system is odourless.

8 Troubleshooting

Contact

For the symptoms listed below, you can try to solve the problem yourself. For any other problem, contact your installer. You can find the contact/helpdesk number via the user interface.

1	Go to [8.3]: Information > Dealer information.	
---	--	--

8.1 To display the help text in case of a malfunction

In case of a malfunction, the following will appear on the home screen depending on the severity:

- : Error
- : Malfunction

You can get a short and a long description of the malfunction as follows:

1	Press the left dial to open the main menu and go to Malfunctioning. Result: A short description of the error and the error code is displayed on the screen.	
2	Press ? in the error screen. Result: A long description of the error is displayed on the screen.	?

8.2 To check the malfunction history

Conditions: The user permission level is set to advanced end user.

1	Go to [8.2]: Information > Malfunction history.	
---	---	--

You see a list of the most recent malfunctions.

8.3 Symptom: You are feeling too cold (hot) in your living room

Possible cause	Corrective action
The desired room temperature is too low (high).	Increase (decrease) the desired room temperature. See "5.6.2 To change the desired room temperature" [▶ 12]. If the problem recurs daily, do one of the following: <ul style="list-style-type: none"> • Increase (decrease) the room temperature preset value. See the user reference guide. • Adjust the room temperature schedule. See "5.8 Schedule screen: Example" [▶ 13].
The desired room temperature cannot be reached.	Increase the desired leaving water temperature in accordance with the heat emitter type. See "5.6.3 To change the desired leaving water temperature" [▶ 12].
The weather-dependent curve is set incorrectly.	Adjust the weather-dependent curve. See the user reference guide.

8.4 Symptom: The water at the tap is too cold

Possible cause	Corrective action
You ran out of domestic hot water because of unusually high consumption.	If you immediately need domestic hot water, activate the DHW tank Powerful operation. However, this consumes extra energy. See "5.7.4 Using DHW powerful operation" [▶ 13].
The desired DHW tank temperature is too low.	If the problems recurs daily, do one of the following: <ul style="list-style-type: none"> ▪ Increase the DHW tank temperature preset value. See the user reference guide. ▪ Adjust the DHW tank temperature schedule. Example: Program to additionally heat up the DHW tank to a preset value (Eco setpoint = lower tank temperature) during the day. See "5.8 Schedule screen: Example" [▶ 13].

8.5 Symptom: Heat pump failure



When the heat pump fails to operate, the backup heater can serve as an emergency heater. It then takes over the heat load either automatically or by manual interaction.

- When Emergency is set to Automatic and a heat pump failure occurs, the backup heater automatically takes over the domestic hot water production and space heating.
- When Emergency is set to Manual and a heat pump failure occurs, the domestic hot water heating and space heating stops.

To manually recover it via the user interface, go to the Malfunctioning main menu screen and confirm whether the backup heater can take over the heat load or not.

- Alternatively, when Emergency is set to:
 - auto SH reduced/DHW on, space heating is reduced but domestic hot water is still available.
 - auto SH reduced/DHW off, space heating is reduced and domestic hot water is NOT available.
 - auto SH normal/DHW off, space heating operates as normally but domestic hot water is NOT available.

Similarly as in Manual mode, the unit can take the full load with the backup heater if the user activates this via the Malfunctioning main menu screen.

When the heat pump fails,  or  will appear on the user interface.



Possible cause	Corrective action
Heat pump is damaged.	See "8.1 To display the help text in case of a malfunction" [▶ 18].



INFORMATION

When the backup heater takes over the heat load, electricity consumption will be considerably higher.



8.6 Symptom: The system is making gurgling noises after commissioning

Possible cause	Corrective action
There is air in the system.	Purge air from the system. ^(a)
Incorrect hydraulic balance.	To be performed by the installer: <ol style="list-style-type: none"> 1 Perform hydraulic balancing to assure that the flow is correctly distributed between the emitters. 2 If hydraulic balancing is not sufficient, change the pump limitation settings ([9-0D] and [9-0E] if applicable).
Various malfunctions.	Check if  or  is displayed on the home screen of the user interface. See "8.1 To display the help text in case of a malfunction" [▶ 18] for more information about the malfunction.

^(a) We recommend to purge air with the air purge function of the unit (to be performed by the installer). If you purge air from the heat emitters or collectors, mind the following:



WARNING

Air purging heat emitters or collectors. Before you purge air from heat emitters or collectors, check if  or  is displayed on the home screen of the user interface.

- If not, you can purge air immediately.
- If yes, make sure that the room where you want to purge air is sufficiently ventilated. **Reason:** Refrigerant might leak into the water circuit, and subsequently into the room when you purge air from the heat emitters or collectors.

9 Disposal



NOTICE

Do NOT try to dismantle the system yourself: dismantling of the system, treatment of the refrigerant, oil and other parts MUST comply with applicable legislation. Units MUST be treated at a specialised treatment facility for reuse, recycling and recovery.

10 Glossary

DHW = Domestic hot water

Hot water used, in any type of building, for domestic purposes.

LWT = Leaving water temperature

Water temperature at the water outlet of the unit.

11 Installer settings: Tables to be filled in by installer

11 Installer settings: Tables to be filled in by installer

11.1 Configuration wizard

Setting	Fill in...
System	
Indoor unit type (read only)	
Backup heater type (read only) [9.3.1]	
Domestic hot water [9.2.1]	
Emergency [9.5]	
Number of zones [4.4]	
Backup heater	
Voltage [9.3.2]	
Maximum capacity [9.3.9]	
Main zone	
Emitter type [2.7]	
Control [2.9]	
Setpoint mode [2.4]	
Schedule [2.1]	
WD curve type [2.E]	
Additional zone (only if [4.4] = 1, dual zone)	
Emitter type [3.7]	
Control (read only) [3.9]	
Setpoint mode [3.4]	
Schedule [3.1]	
WD curve type [3.C]	
Tank	
Heat up mode [5.6]	
Comfort setpoint [5.2]	
Eco setpoint [5.3]	
Reheat setpoint [5.4]	

11.2 Settings menu

Setting	Fill in...
Main zone	
Ext thermostat type [2.A]	
Additional zone (if applicable)	
Ext thermostat type [3.A]	
Information	
Dealer information [8.3]	

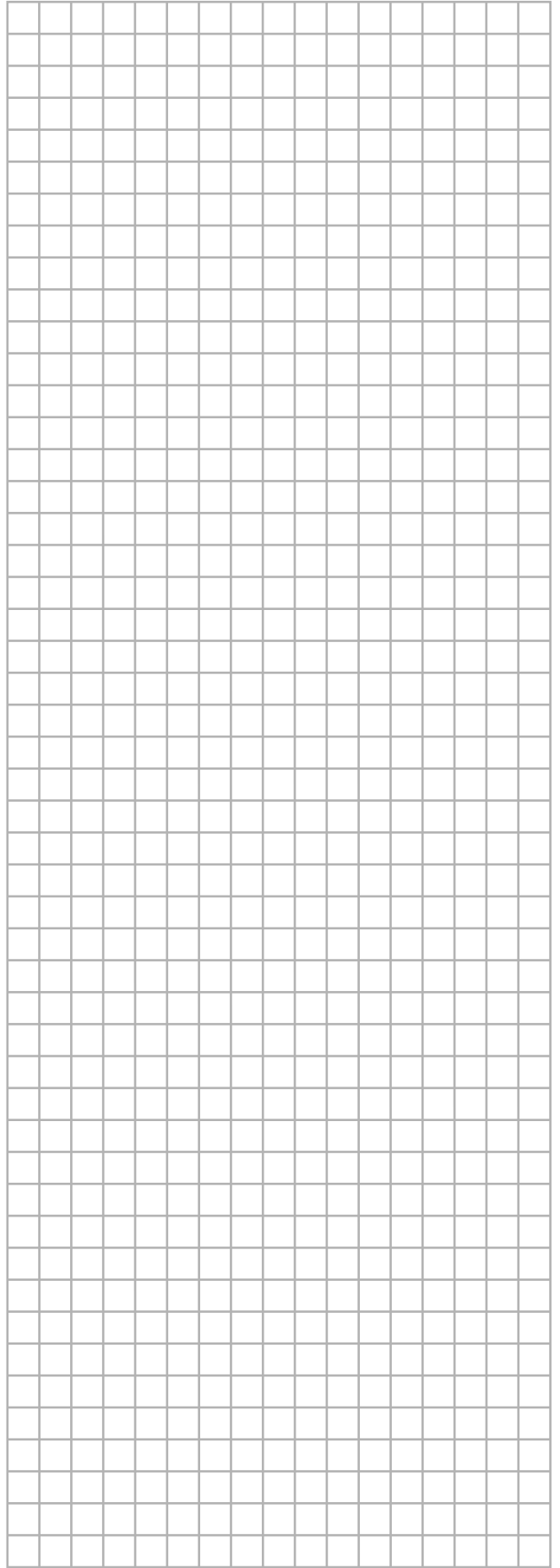
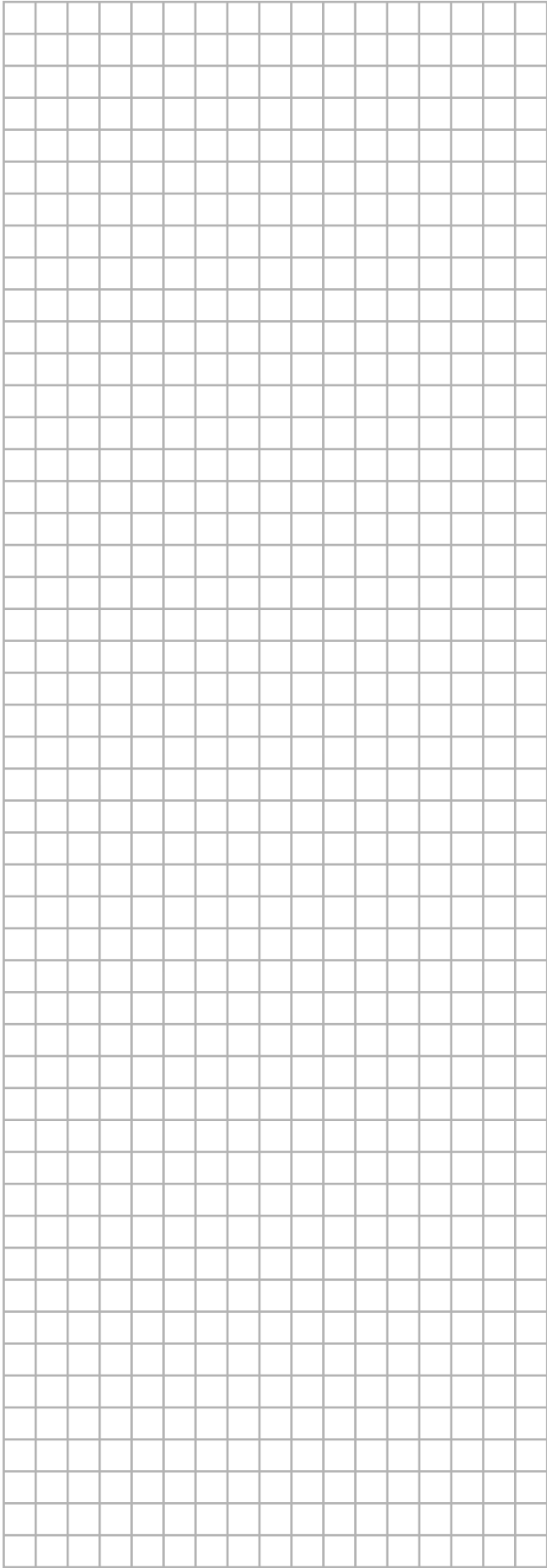

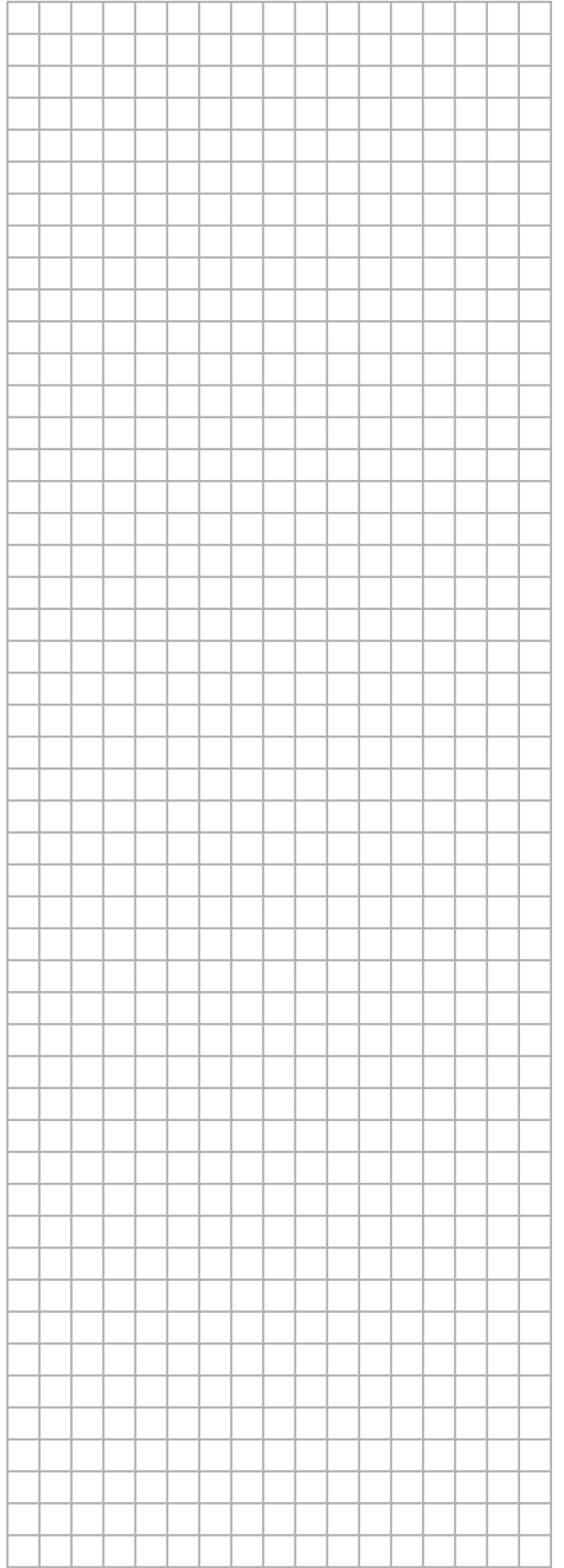
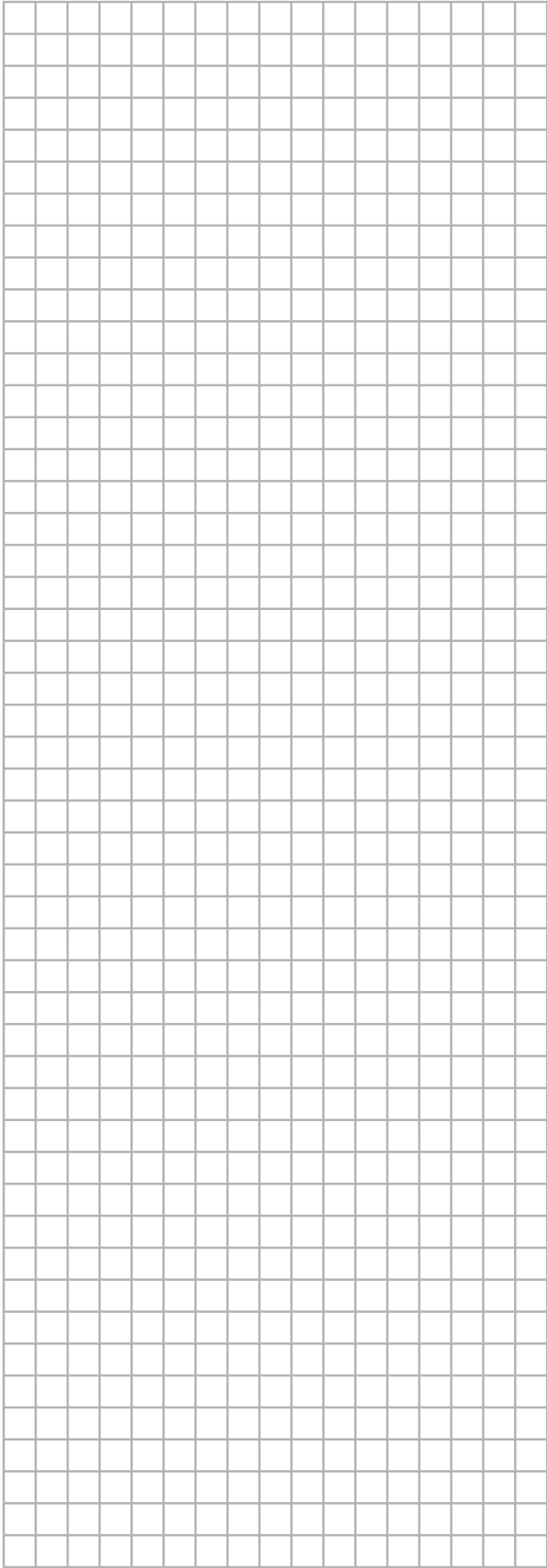

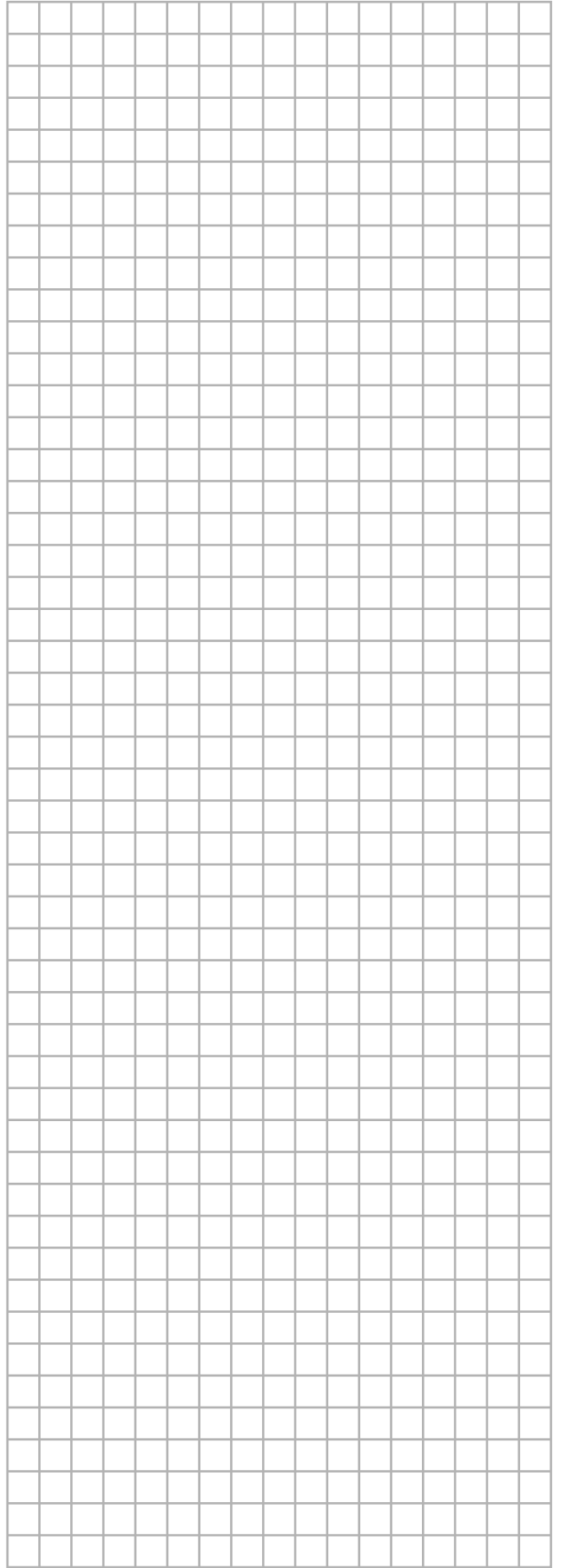
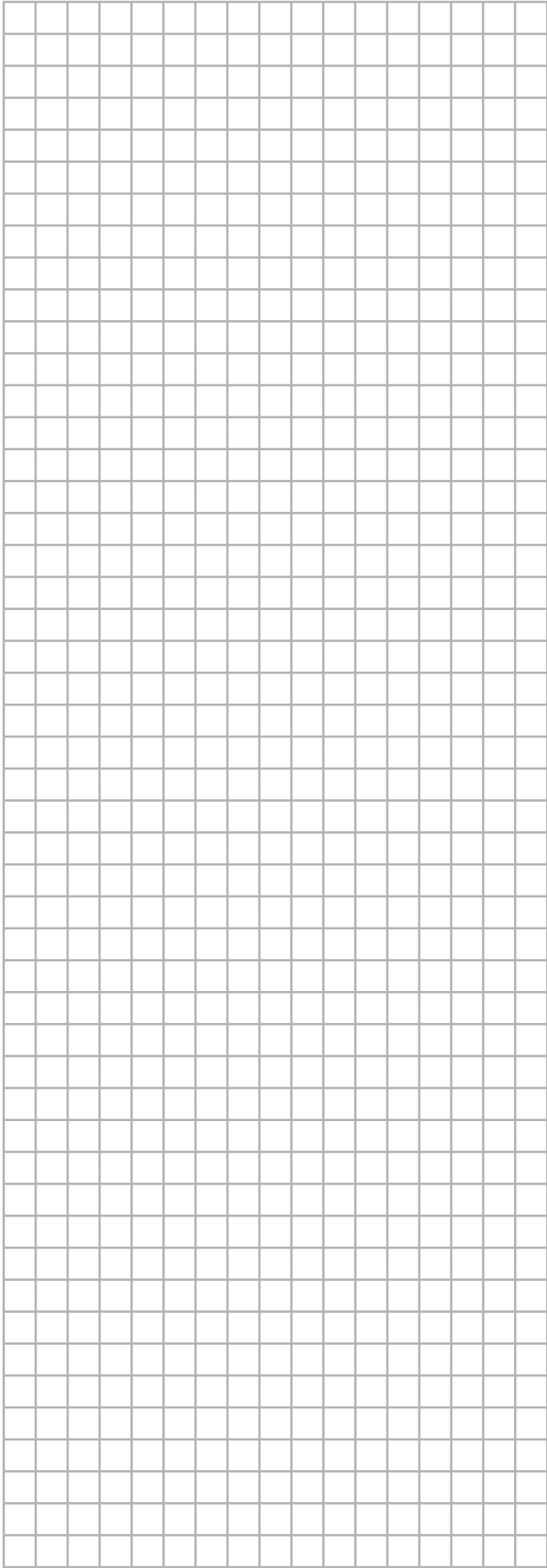



4P569812-2 C 00000004

Copyright 2019 Daikin

DAIKIN EUROPE N.V.

Zandvoordestraat 300, B-8400 Oostende, Belgium

4P569812-2C 2023.02